













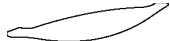
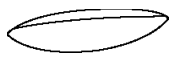

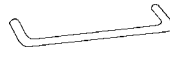

Accessory Workbook

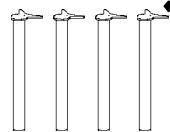
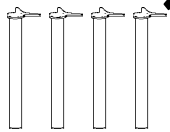
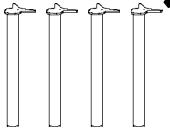
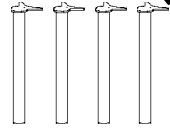

Techline Accessory Workbook - 1

	Article	Description	Dimensions			Line	
			W (Nominal)	H (Nominal)	D (Nominal)	Series 2	Arch. Casework
	900006	Curved Strap Pull (801) - 96 mm Satin Chrome	4	-	1	X	X
	900007	Curved Trimline Pull (802) - 96 mm Satin Chrome	4	-	1	X	X
	900015	Curved Pull (601) - 96 mm Black	6	-	1	X	X
	900016	Curved Pull (601) - 96 mm Pewter	6	-	1	X	X
	900008	Curved Wide Ellipse Pull (803) - 96 mm Satin Chrome	4	-	1	X	X
	900009	Eyelid Pull (804) - 96 mm Satin Chrome	4	-	1	X	X

	Article	Description	Dimensions			Line	
			W (Nominal)	H (Nominal)	D (Nominal)	Series 2	Arch. Casework
	900010	Mini Eyelid Pull (805) - 32 mm Satin Chrome	2	-	2	X	
	900011	Standard Pull (401) - 96 mm Satin Chrome	4	-	1	X	X
	900012	Standard Pull (401) - 96 mm Black	4	-	1	X	X
	900013	Standard Pull (401) - 96 mm Antique White	4	-	1	X	X
	900014	Standard Pull (401) - 96 mm Arctic White	4	-	1	X	X

Techline Accessory Workbook - 2

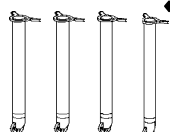
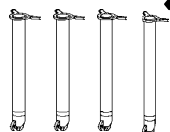
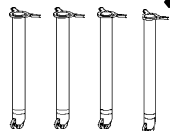
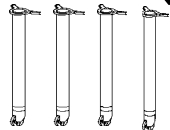
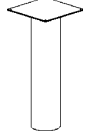
	Article	Description	Dimensions			Line	
			W (Nominal)	H (Nominal)	D (Nominal)	Series 2	Arch. Casework
	900200	New 4-pack 2" Metal Leg - Pewter	2	28	2	X	
	900201	New 4-pack 2" Metal Leg - Black	2	28	2	X	
	900202	New 4-pack 2" Metal Leg - Satin Chrome	2	28	2	X	
	900203	New 4-pack 2" Metal Leg - Aluminum	2	28	2	X	
	900204	New 1-pack 2" Metal Leg - Pewter	2	28	2	X	
	900205	New 1-pack 2" Metal Leg - Black	2	28	2	X	
	900206	New 1-pack 2" Metal Leg - Satin Chrome	2	28	2	X	
	900207	New 1-pack 2" Metal Leg - Aluminum	2	28	2	X	

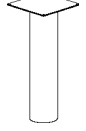
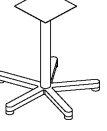
	Article	Description	Dimensions			Line	
			W (Nominal)	H (Nominal)	D (Nominal)	Series 2	Arch. Casework
	900208	New 4-pack 2" Rolling Leg - Pewter	2	28	2	X	
	900209	New 4-pack 2" Rolling Leg - Black	2	28	2	X	
	900210	New 4-pack 2" Rolling Leg - Satin Chrome	2	28	2	X	
	900211	New 4-pack 2" Rolling Leg - Aluminum	2	28	2	X	
	900212	6" Cylinder Base - Pewter	6	28	6	X	
	900213	6" Cylinder Base - Black	6	28	6	X	
	900214	6" Cylinder Base - Aluminum	6	28	6	X	
	900215	Pedestal Base - Black	27	28	27	X	

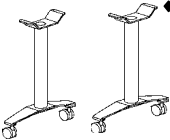
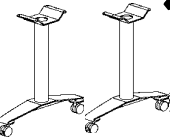
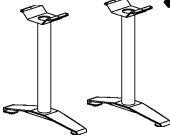
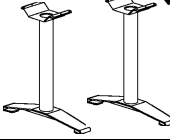
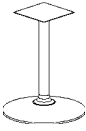
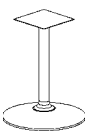

Techline Accessory Workbook - 3

	Article	Description	Dimensions			Line	
			W (Nominal)	H (Nominal)	D (Nominal)	Series 2	Arch. Casework
	900217	Trestle Leg - Black	3	25	18	X	
	900219	Trestle Leg - Black	3	28	24	X	
	900221	Trestle Leg - Black	3	28	24	X	
	900222	Trestle Leg - Aluminum	3	28	18	X	
	900223	Round Pedestal - Black	21	28	27	X	
	900224	Round Pedestal - Black	27	28	27	X	

	Article	Description	Dimensions			Line	
			W (Nominal)	H (Nominal)	D (Nominal)	Series 2	Arch. Casework
Not Illustrated	900300	Touchup Crayon - Arctic White	-	-	-	X	X
Not Illustrated	900301	Touchup Crayon - Antique White (2 pack)	-	-	-	X	X
Not Illustrated	900302	Touchup Crayon - Kensington Maple (2 pack)	-	-	-	X	X
Not Illustrated	900303	Touchup Crayon - American Cherry (2 pack)	-	-	-	X	X
Not Illustrated	900304	Touchup Crayon - Fine Oak (2 pack)	-	-	-	X	X
Not Illustrated	900306	Touchup Crayon - Slate (2 pack)	-	-	-	X	X
Not Illustrated	900307	Touchup Crayon - Opal Gray (2 pack)	-	-	-	X	X

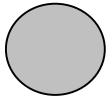
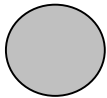
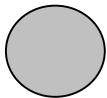
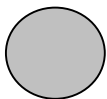
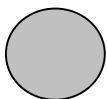
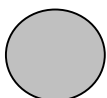
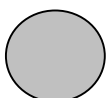
Techline Accessory Workbook - 4

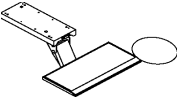
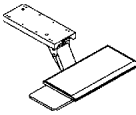
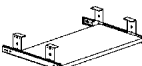
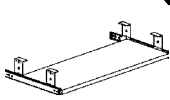
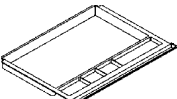

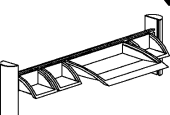

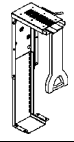
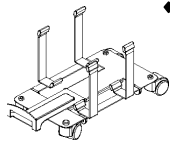
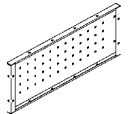
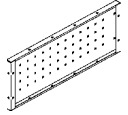
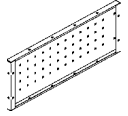
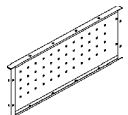

	Article	Description	Dimensions			Line	
			W (Nominal)	H (Nominal)	D (Nominal)	Series 2	Arch. Casework
	♦ 900350	18mm Cover Caps - Arctic White (100 per pkg.)	-	-	-	X	X
	♦ 900351	18mm Cover Caps - Antique White (100 per pkg.)	-	-	-	X	X
	♦ 900352	18mm Cover Caps - Kensington Maple (100 per pkg.)	-	-	-	X	X
	♦ 900353	18mm Cover Caps - American Cherry (100 per pkg.)	-	-	-	X	X
	♦ 900354	18mm Cover Caps - Fine Oak (100 per pkg.)	-	-	-	X	X
	♦ 900356	18mm Cover Caps - Slate (100 per pkg.)	-	-	-	X	X
	♦ 900357	18mm Cover Caps - Opal Gray (100 per pkg.)	-	-	-	X	X

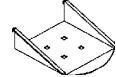
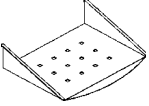
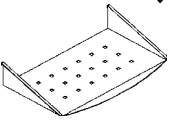
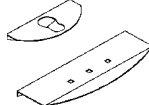
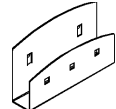
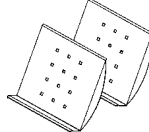



	Article	Description	Dimensions			Line	
			W (Nominal)	H (Nominal)	D (Nominal)	Series 2	Arch. Casework
	♦ 900400	Keyboard Mechanism - Black	29	5	10	X	X
	♦ 900401	Keyboard Mechanism with Ball Bearing - Black	29	5	10	X	X
 color: _____	♦ 900402	21" Keyboard Tray (3/4"H tray) - 7 Laminate Choices	21	.75	11	X	X
 color: _____	♦ 900428	28" Keyboard Tray (3/4"H tray) - 7 Laminate Choices	28	.75	11	X	X
	♦ 900403	Pencil Drawer - Black	21	2	16	X	X
	♦ 900404	Pencil Tray - Black (10 pack)	13	10	1	X	X
	♦ 900405	Desktop Organizer w/ Trays	34	10	-	X	



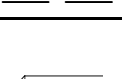

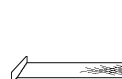
Techline Accessory Workbook - 5

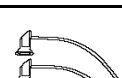

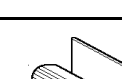
	Article	Description	Dimensions			Line	
			W (Nominal)	H (Nominal)	D (Nominal)	Series 2	Arch. Casework
	900406	Corner Sleeve - Black	16	1	8	X	
	900407	CPU Holder - Black	8	15	6	X	
	900408	CPU Trolley - Black	9	9	20	X	
	900409	12" H Screen - Pewter (wall mounting screws included)	30	12	1	X	
	900410	12" H Screen - Pewter (wall mounting screws included)	36	12	1	X	
	900411	18" H Screen - Pewter (wall mounting screws included)	30	18	1	X	
	900412	18" H Screen - Pewter (wall mounting screws included)	36	18	1	X	

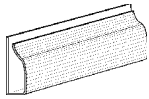
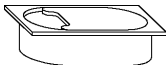

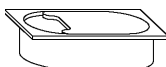
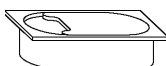
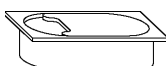

	Article	Description	Dimensions			Line	
			W (Nominal)	H (Nominal)	D (Nominal)	Series 2	Arch. Casework
	900413	6" CD Tray - Pewter (2 Pack)	6	2	7	X	
	900414	12" Letter Tray - Pewter	12	3	9	X	
	900415	16" Legal Tray - Pewter	16	3	10	X	
	900416	Vase Holder and Shelf - Pewter	12	1	3	X	
	900417	File Holder - Pewter (2 Pack)	7	4	1	X	
	900418	Diagonal Letter Tray - Pewter (2 Pack)	6	9	11	X	

	Article	Description	Dimensions			Line	
			W (Nominal)	H (Nominal)	D (Nominal)	Series 2	Arch. Casework
	◆ 900500-000224	Lock Pack for Single Doors/Drawers, keyed random (LP085)	-	-	-	X	X
	◆ 900501-000XXX (225-244)	Lock Pack for Single Doors/Drawers, keyed alike (LP085)	-	-	-	X	X
	◆ 900502-000224	Lock Pack for Double Doors/Drawers, keyed random (LP400)	-	-	-	X	X
	◆ 900503-000XXX (225-244)	Lock Pack for Double Doors/Drawers, keyed alike (LP400)	-	-	-	X	X
	◆ 900504	Master Key	-	-	-	X	X
	◆ 900505	Change Tool	-	-	-	X	X
	◆ 900506-000XXX (225-244)	Key Core	-	-	-	X	X
	◆ 900600	18" Fluorescent Task Light - Black	18	1.5	6.5	X	X

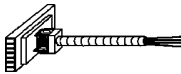
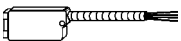
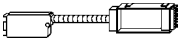
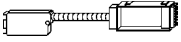
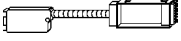
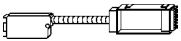

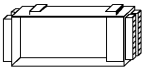

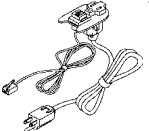
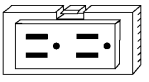
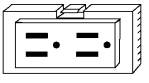
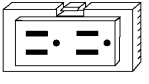
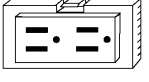
	Article	Description	Dimensions			Line	
			W (Nominal)	H (Nominal)	D (Nominal)	Series 2	Arch. Casework
	◆ 900601	30" Fluorescent Task Light - Black	30	1.5	6.5	X	X
	◆ 900602	Single Halogen Task Light - Black	6	1.3	3.4	X	X
	◆ 900603	Double Halogen Task Light - Black	12	1.3	3.4	X	X
	◆ 900604	Bookcase Lights (set of 3) - Aluminum	1	7	9	X	
Not Illustrated	◆ 900605	24" Connecting Cord (BK24HLC1)	-	-	-	X	X
Not Illustrated	◆ 900606	G-8 Replacement Bulb	-	-	-	X	X
	◆ 900607	1" H Cord Channel (BK1WC6) - Black (6 pack)	96	1	0.5	X	X
	◆ 900608	2" H Cord channel (BK2WC6) - Black (6 pack)	96	2.3	1	X	X



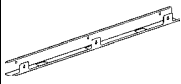
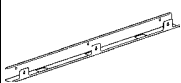
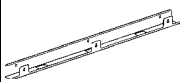
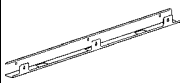
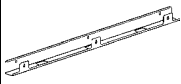
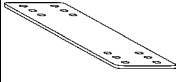
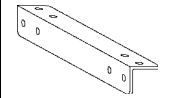

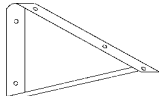
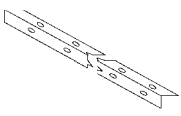
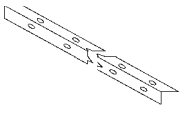
	Article	Description	Dimensions			Line	
			W (Nominal)	H (Nominal)	D (Nominal)	Series 2	Arch. Casework
	900609	3-pack Cord Channel - Black	12	1	3	X	X
	900700	Rectangular Cord Grommet (EC112) - Arctic White	4	1	2	X	X
	900701	Rectangular Cord Grommet (EC112) - Antique White	4	1	2	X	X
	900702	Rectangular Cord Grommet (EC112) - Kensington Maple	4	1	2	X	X
	900704	Rectangular Cord Grommet (EC112) - Midnight Black	4	1	2	X	X
	900705	Rectangular Cord Grommet (EC112) - Slate	4	1	2	X	X
	900706	Rectangular Cord Grommet (EC112) - Opal Gray	4	1	2	X	X
	900712	Retractable Power Center (EC060)	-	-	-	X	

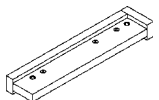
	Article	Description	Dimensions			Line	
			W (Nominal)	H (Nominal)	D (Nominal)	Series 2	Arch. Casework
	900713	Retractable Communications Center (EC061)	-	-	-	X	
	900714	Retractable Communications Center Faceplate (EC070)	-	-	-	X	
	900715	Power Feed (EC020)	72	-	-	X	
	900716	End Power Feed (EC021)	-	-	-	X	
	900717	24" Power Pass-through (EC030)	-	-	-	X	
	900718	36" Power Pass-through (EC031)	-	-	-	X	
	900719	48" Power Pass-through (EC032)	-	-	-	X	
	900720	60" Power Pass-through (EC033)	-	-	-	X	

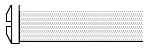
	Article	Description	Dimensions			Line	
			W (Nominal)	H (Nominal)	D (Nominal)	Series 2	Arch. Casework
	900721	Power Block (EC040)	-	-	-	X	
	900722	Mounting Bracket (EC041)	-	-	-	X	
	900723	Power/Data Surface Module (EC080)	-	-	-	X	
	900724	Receptacle (EC050) - Black	-	-	-	X	
	900725	Receptacle (EC051) - Black	-	-	-	X	
	900726	Receptacle (EC052) - Black	-	-	-	X	
	900727	Receptacle (EC053) - Black	-	-	-	X	
	900728	Power/Data Dome (EC081) - Black	-	-	-	X	

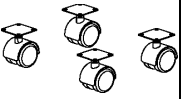
	Article	Description	Dimensions			Line	
			W (Nominal)	H (Nominal)	D (Nominal)	Series 2	Arch. Casework
	900729	Data Jack (EC083)	-	-	-	X	
	900730	25" Wire Management Channel - Pewter	25	3	2	X	
	900731	31" Wire Management Channel - Pewter	31	3	2	X	
	900732	43" Wire Management Channel - Pewter	43	3	2	X	
	900733	51" Wire Management Channel - Pewter	51	3	2	X	
	900734	61" Wire Management Channel - Pewter	61	3	2	X	
	900800	10" Universal Connector Plate - Gray (2-pack)	10	0.1	2	X	X
	900801	10" Angle Support - Gray (2 Pack)	1	10	1	X	X

	Article	Description	Dimensions			Line	
			W (Nominal)	H (Nominal)	D (Nominal)	Series 2	Arch. Casework
	900802	Steel Support Bracket (SB01) - Gray	1	12	18	X	X
	900804	23° Angle Support (SA002) - Gray	1	23	1	X	X
	900805	48° Angle Support (SA004) - Gray	1	48	1	X	X
 color: _____	900808	Laminate Support Bracket - 7 Laminate Choices	4	19	19	X	X
	900809	Drilling Template	-	-	-	X	X
	900810	10 x 3" Panhead Screw (Qty 100) (HW301)	-	-	-	X	X
	900811	Connector Sleeve (Qty 100)	-	-	-	X	X

	Article	Description	Dimensions			Line	
			W (Nominal)	H (Nominal)	D (Nominal)	Series 2	Arch. Casework
Not Illustrated	900812	Machine Screws (Qty 100)	-	-	-	X	X
	900813	4-pack Casters - Black	-	-	-	X	
	900814	120 Degree Hinge (Qty 2)	-	-	-	X	X
	900815	170 Degree Hinge (Qty 2)	-	-	-	X	X
	900817	Slide 300mm Full Extension 100# (1 pair)	-	-	-	X	
	900818	Slide 450mm Full Extension 100# (1 pair)	-	-	-	X	X

Techline Accessory Workbook - 10

	Article	Description	Dimensions			Line	
			W (Nominal)	H (Nominal)	D (Nominal)	Series 2	Arch. Casework
	♦ 900819	Slide 550mm Full Extension 100# (1 pair)	-	-	-	X	X
	♦ 900820	Slide 450mm Full Extension 150# (1 pair)	-	-	-	X	X
	♦ 900823	AC Shelf Support Pack - 5mm "L" (2 w/ Pin Metal, 2 w/o Pin Metal)	-	-	-		X
	♦ 900826	Shelf Support 5mm Zinc - Qty 4	-	-	-	X	
Not Illustrated	♦ 900827	File Rail Pack 32"W x 20"D	-	-	-	X	X
	♦ 900828	Leveler Feet w/ Propeller Nut - Qty 4	-	-	-	X	X

	Article	Description	Dimensions			Line	
			W (Nominal)	H (Nominal)	D (Nominal)	Series 2	Arch. Casework
Not Illustrated	♦ 900829	File Rail Pack 16"W x 20"D	-	-	-	X	X
Not Illustrated	♦ 900830	File Rail Pack 16"W x 24"D	-	-	-	X	X
Not Illustrated	♦ 900831	File Rail Pack 20"W x 20"D	-	-	-		X
Not Illustrated	♦ 900832	File Rail Pack 20"W x 24"D	-	-	-		X
Not Illustrated	♦ 900833	File Rail Pack 24"W x 20"D	-	-	-	X	X
Not Illustrated	♦ 900834	File Rail Pack 24"W x 24"D	-	-	-	X	X